



The Glidevale range of Fresh wall ventilators has been specially designed to introduce fresh air into our homes in order to control condensation, and being non-electrical they use no energy to operate.

FRESH WALL VENTILATORS



Superior performance Glidevale wall ventilators direct the airflow from around the centre of the room. Many other wall vents only feed air direct from outside, without dispersing it, which can cause draughts.

Glidevale wall vents are designed to allow air to enter the building to provide the stated levels of background ventilation to meet the requirements of Building Regulations. Geometric free areas are included for Scottish Building Regulations.

Acoustic options not only provide the stated levels of background ventilation, but also noise attenuation for buildings which may be situated where external noise could pose a disturbance to the occupant for example, near busy roads.

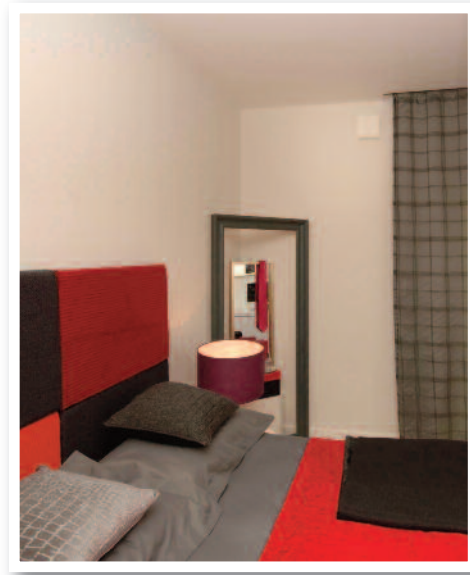

Including new humidity-sensitive vents
Fresh 99H & 99HdB



To ventilate a property, two elements are required: the extraction of moist, stale air and the supply of fresh air.

The need for fresh air and ventilation

A supply of fresh air is needed for a ventilation system to work. Fresh air is needed to replace stale air; it helps to reduce the amount of moisture within the air and also circulates the air within a room.

Without sufficient ventilation the moist, stale air can make rooms stuffy and uncomfortable. It can also cause harmful condensation.

The problem with condensation

Condensation is the main cause of damp and mould within buildings so failure to control it can have a significant impact. Mould and damp can affect the health of the occupant and the fabric of the building. Mould spores can have implications on the lungs and can make breathing difficult for those with asthma or bronchial illnesses. Damp can leave stains on the wall, can lead to plaster perishing and even affect the structure of a building.

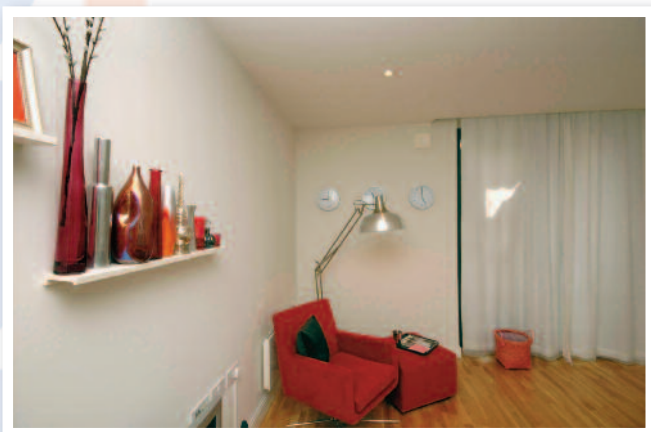

The Glidevale solution

Glidevale's range of wall vents enable fresh air to be input into a building to ensure a healthy atmosphere and reduce the potential for condensation and mould. Wall vents are fitted through the wall and ducted to an outside grille. They are available with various manual control mechanisms.

Features and benefits

- All types are non-electrical and use no energy to operate.
- Vents direct the airflow from around the centre of the room to ventilate the room properly.
- Simple to install.
- Acoustic wall vents are available with enhanced sound reduction properties of up to 50dB.
- The wall sleeve is suitable for any wall thickness up to 360mm (other sizes available as special order).
- An external grille incorporates an integral fly screen to stop swarming insects entering the room or nesting within the duct.
- Made from recyclable ABS.
- Internal controller available in white as standard, and external grille in terracotta as standard.
- RAL colour matching available to order (contact us for pricing).

Optional extras for all models

- Pollen filter (special order) excluding Fresh 99H & 99HdB.
 - Acoustic cowl.
 - Storm shield to prevent draughts in windy locations.
 - Additional wall sleeves / alternative sizes (special order).
 - Flimmafilter (compatible with Fresh TLF) filters out pollutants to improve indoor air quality.
-

STANDARD WALL VENTILATORS

Glidevale offers a range of manually controlled standard vents, which allow the user to open and close the vents as required.

Also available is the Fresh 99H, an automatic unit which opens and closes dependent on relative humidity, thus reducing the potential for condensation. The product does not require any manual interaction to operate.

Fresh 80

Non-electric through wall vent provides controllable background ventilation. Supplied as controllable internal vent, ducting and external grille.

Features

- Manual pull cord operation.
- Trickle facility possible even when 'closed' to ensure fresh air ingress.
- Filter and condensation protection incorporated.
- Ventilation levels can be controlled to set levels.



External grille 115 x 115mm

Fresh 90

Non-electric through wall vent provides controllable background ventilation. Supplied as controllable internal vent, ducting and external grille.

Features

- Manual slider operation, controls internal iris to modulate airflow.
- Trickle facility possible even when 'closed' to ensure fresh air ingress.
- Filter and condensation protection incorporated.
- Ventilation levels can be controlled to set levels.



External grille 140 x 140mm

Material for all models

Body: Recyclable ABS.

Colour: Internal controller – white

External grille – terracotta

Colour matched to RAL available, (contact us for pricing).

Please note

100-110mm diameter core bit required for fitting.

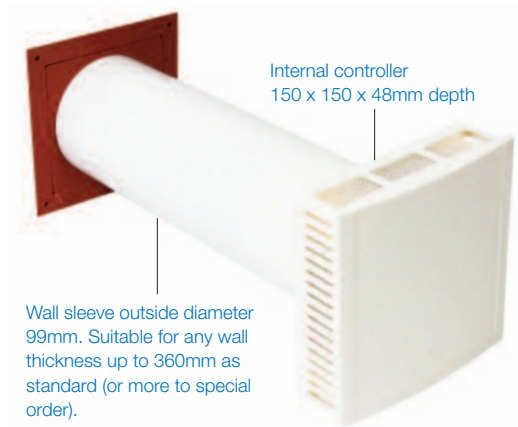

Performance and Dimensions

Product	Standard operation	Trickle facility	Ventilation equivalent area*	Geometric free area	Airflow rate @10Pa
Fresh 80	Manual control via pull cord	Yes	2230mm ²	4000mm ²	5.6 l/s
Fresh 90	Manual control via slider**	Yes	2880mm ²	5600mm ²	7.2 l/s
Fresh 100	Manual control via pull cord	Yes	3760mm ²	5600mm ²	9.4 l/s
Fresh TLF	Manual control via slider**	Yes	2910mm ²	5000mm ²	7.3 l/s
Fresh 99H	Automatic humidity control	Yes	4210mm ²	5600mm ²	10.5 l/s

* calculated as an average of both airflow directions, rounded down to the nearest 10

**slider found at bottom of vent

25%

IMPROVEMENT
IN VENTILATION
EQUIVALENT
AREA

Fresh 100

Non-electric through wall vent provides controllable background ventilation. Supplied as controllable internal vent, ducting and external grille.

Features

- Manual pull cord operation.
- Trickle facility possible even when 'closed' to ensure fresh air ingress.
- Filter and condensation protection incorporated.
- Ventilation levels can be controlled to set levels.



External grille 140 x 140mm

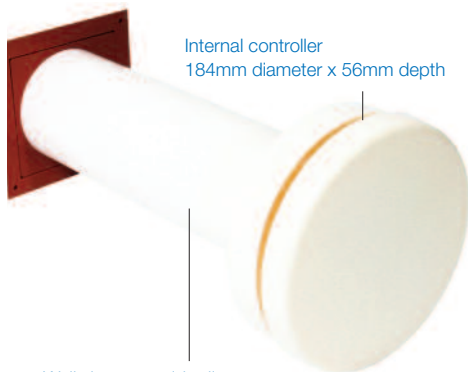

Internal controller
184mm diameter x 56mm depth

Wall sleeve outside diameter 99mm. Suitable for any wall thickness up to 360mm as standard (or more to special order).

Fresh TLF

Non-electric through wall vent provides controllable background ventilation. Supplied as controllable internal vent, ducting and external grille.

Features

- Manual slider operation controls internal iris to regulate airflow.
- Filter and condensation protection incorporated.
- Enhanced aesthetic appearance.
- Design enhances airflow pattern locations.



External grille 150 x 150mm



Internal controller
168 x 156mm x 46mm depth

Wall sleeve outside diameter 102mm. Suitable for any wall thickness up to 350mm as standard (or more to special order).

Fresh 99H humidity-sensitive

Non-electrical, humidity-sensitive through wall vent provides controllable, responsive background ventilation. Supplied as automatic internal vent, ducting and external grille.

Features

- Automatic opening / closing dependent upon relative humidity (RH).
- Energy saving through reduced heat loss.
- Operating range 35% to 75% RH.
- Trickle facility even when 'closed' to ensure fresh air ingress.



External grille 140 x 140mm

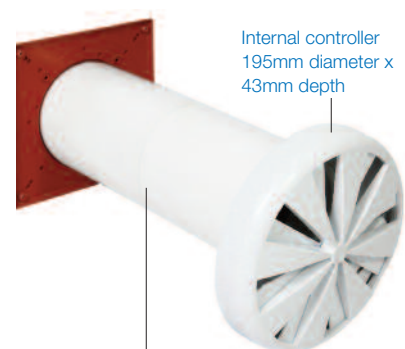

Internal controller
195mm diameter x
43mm depth

Wall sleeve outside diameter 99mm. Suitable for any wall thickness up to 350mm as standard (or more to special order).

ACOUSTIC WALL VENTILATORS

Glidevale's acoustic wall vents reduce the amount of noise ingress from outside, making them suitable for use in applications where there are high levels of external noise such as near main roads, airports or railway lines.

Fresh 80dB

Non-electric acoustic though wall vent, provides controlled background ventilation and noise attenuation up to 50dB Dn,e,w. Supplied as controllable internal vent, acoustic ducting and external grille.

Features

- Substantial sound reduction up to 50dB Dn,e,w.
- Trickle facility to allow air ingress even when closed.
- Filter and condensation protection incorporated.
- For 300mm wall thickness as standard, longer length available.

Fresh 90dB

Non-electric acoustic though wall vent, provides controlled background ventilation and noise attenuation up to 45dB Dn,e,w. Supplied as controllable internal vent, acoustic ducting and external grille.

Features

- Sound reduction up to 43dB Dn,e,w.
- Manual slider operation, controls internal iris to modulate airflow.
- Trickle facility possible even when 'closed' to ensure fresh air ingress.
- Filter and condensation protection incorporated.
- Ventilation levels can be controlled to set levels.

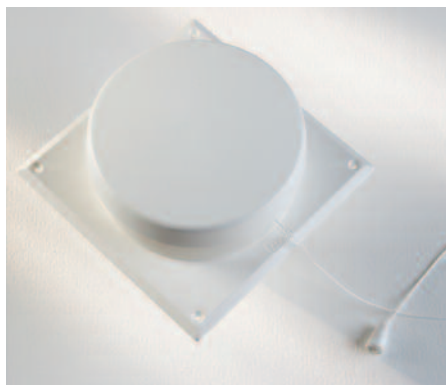

External grille 165 x 165mm



External grille 165 x 165mm

Material for all acoustic models

Body: Recyclable ABS

Duct: Glass fibre with PVC skin

Colour: Internal controller – white

External grille – terracotta

Colour matched to RAL available

(contact us for pricing).

Please note

145-150mm diameter core bit required for fitting.

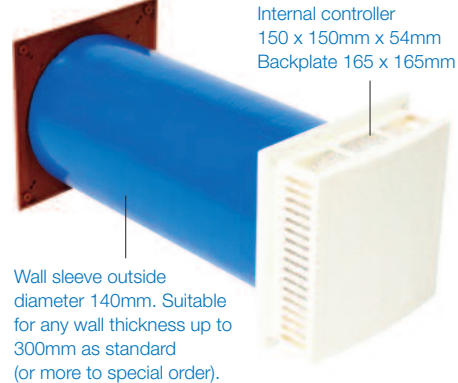
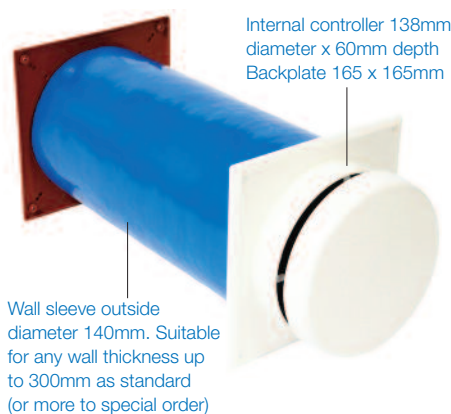

Performance and Dimensions

Product	Standard operation	Trickle facility	Ventilation equivalent area*	Geometric free area	Airflow rate @10Pa	Sound reduction up to
Fresh 80dB	Manual control via pull cord	Yes	2250mm ²	4000mm ²	5.6 l/s	50dB Dn,e,w
Fresh 90dB	Manual control via slider**	Yes	2910mm ²	5600mm ²	7.3 l/s	43dB Dn,e,w
Fresh 100dB	Manual control via pull cord	Yes	3210mm ²	5600mm ²	7.9 l/s	42dB Dn,e,w
Fresh TLF-dB	Manual control via slider**	Yes	2530mm ²	5000mm ²	6.3 l/s	46dB Dn,e,w
Fresh 99HdB	Automatic humidity control	Yes	3930mm ²	5600mm ²	9.8 l/s	40dB Dn,e,w

* calculated as an average of both airflow directions, rounded down to the nearest 10

**slider found at bottom of vent

ACOUSTIC WALL VENTILATORS

Fresh 100dB

Non-electric, acoustic through wall vent provides controllable background ventilation and noise reduction up to 42dB Dn,e,w.

Supplied as controllable internal vent, acoustic ducting and external grille.

Features

- Sound reduction up to 42dB Dn,e,w.
- Manual pull cord operation.
- Trickle facility possible even when 'closed' to ensure fresh air ingress.
- Filter and condensation protection incorporated.

Fresh TLF-dB

Non-mechanical acoustic through wall vent provides controllable background ventilation and noise reduction to 46dB Dn,e,w.

Supplied as controllable internal vent, acoustic ducting and external grille.

Features

- Sound reduction up to 46dB Dn,e,w
- Manual slider operation controls internal iris to regulate airflow.
- Filter and condensation protection incorporated.
- Enhanced aesthetic appearance.

Fresh 99HdB humidity-sensitive

Non-electric acoustic, humidity-sensitive vent provides background ventilation and noise reduction to 43dB Dn,e,w.

Supplied as automatic humidity-sensitive internal vent, acoustic ducting and external grille.

Features

- Sound reduction up to 40dB Dn,e,w.
- Automatic opening/closing dependent on relative humidity (RH).
- Operating range 35% to 75% RH.
- Trickle facility even when 'closed' to ensure fresh air ingress.



External grille
165 x 165mm

Internal controller 184mm
diameter x 65mm depth
Backplate 210 x 210mm



Wall sleeve outside
diameter 140mm.
Suitable for any wall
thickness up to 300mm
as standard (or more
to special order).

External grille 150 x 150mm

Internal controller
168 x 156mm x 54mm
Backplate 180 x 180mm

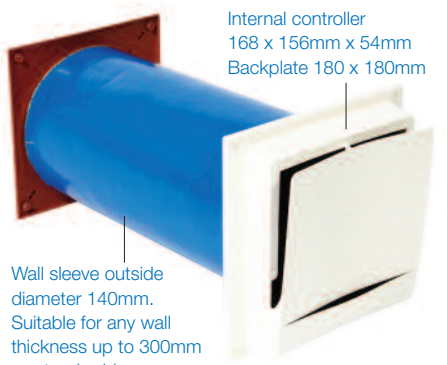

Wall sleeve outside
diameter 140mm.
Suitable for any wall
thickness up to 300mm
as standard (or more
to special order).

External grille 165 x 165mm

Internal controller
195mm diameter
x 43mm depth

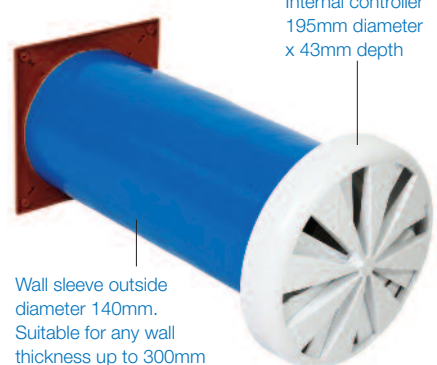

Wall sleeve outside
diameter 140mm.
Suitable for any wall
thickness up to 300mm
as standard (or more
to special order).

Stockist's stamp

GLIDEVALE

2 Brooklands Road, Sale, Cheshire M33 3SS

Tel: 0161 905 5700 Fax: 0161 905 2085

Email: info@glidevale.com Web: www.glidevale.com

Glidevale maintains a policy of continuous development and reserves the right to amend product specifications without notice.



A division of Building Product Design Ltd. Company Registration No; 3944123

